

a little room
 architect: **STUDIO LEVENO_ amy wynne_ mark leveno**

Austin Texas

Each time a temporary structure is installed it has the potential to be reinvented. A Little Room is an art gallery that is easily assembled, disassembled and transported. The design takes advantage of the reconstruction phase by establishing a straightforward framework that can be endlessly adapted. Artists may add and subtract panels, frames and a fabric scrim, choose their materials and apply their art directly to the panel surfaces. By offering possibilities that allow the manipulation of light, color, materials and levels of enclosure, each artist is able to configure A Little Room to best display their art. The galleries themselves become works of art.

A Little Room prototype was configured for a curated show as part of Art City Austin. Though constructed as a solitary object it has been designed with the option to become an interconnected field of gallery spaces. The grouping of galleries will create an eclectic collection of art spaces within a consistent framework.

A Little Room allows the art gallery experience to appear wherever and however an artist chooses, whether that be on a city street, indoors or in a remote field. A Little Room is an art space as creative as the artist.

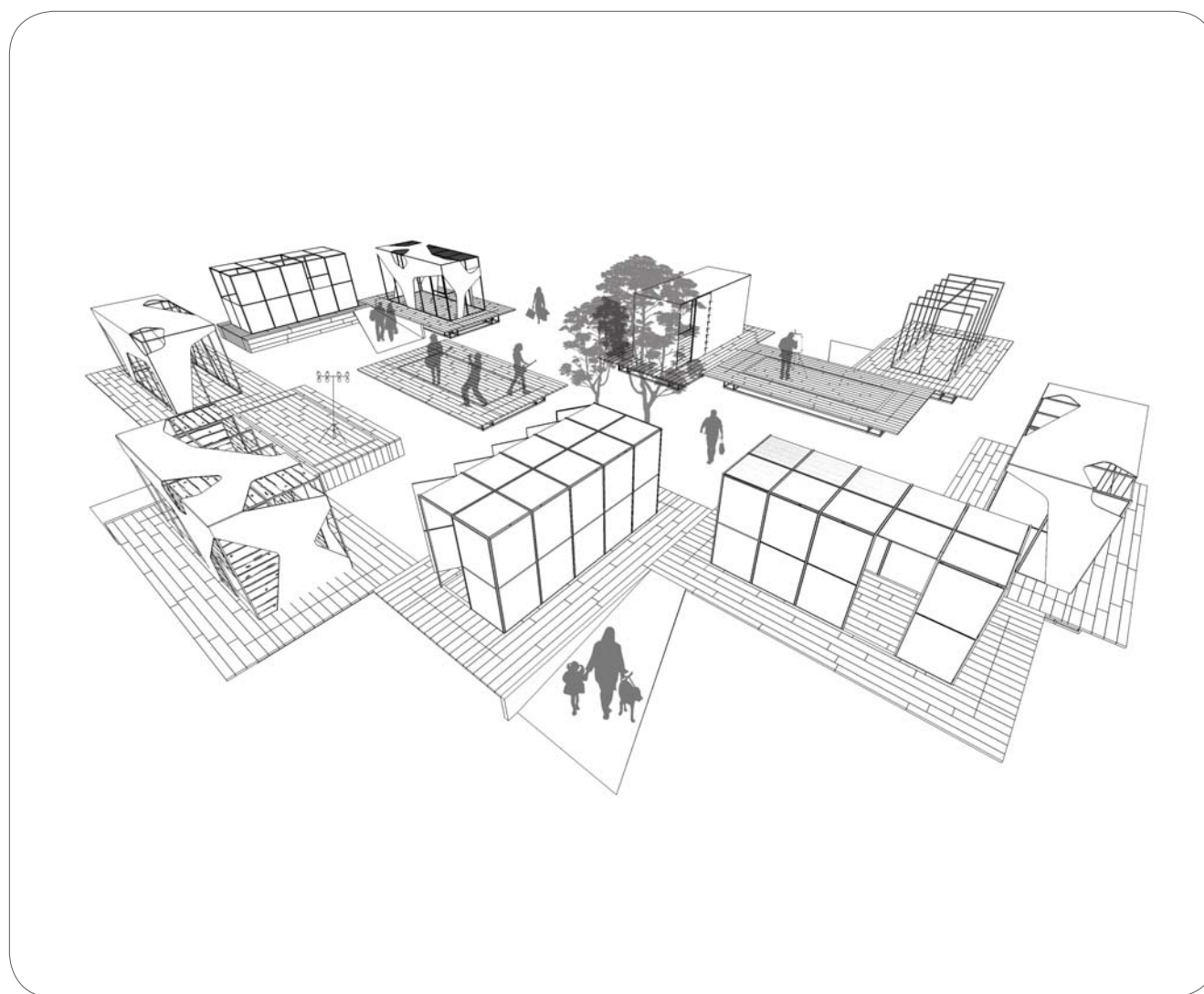

1

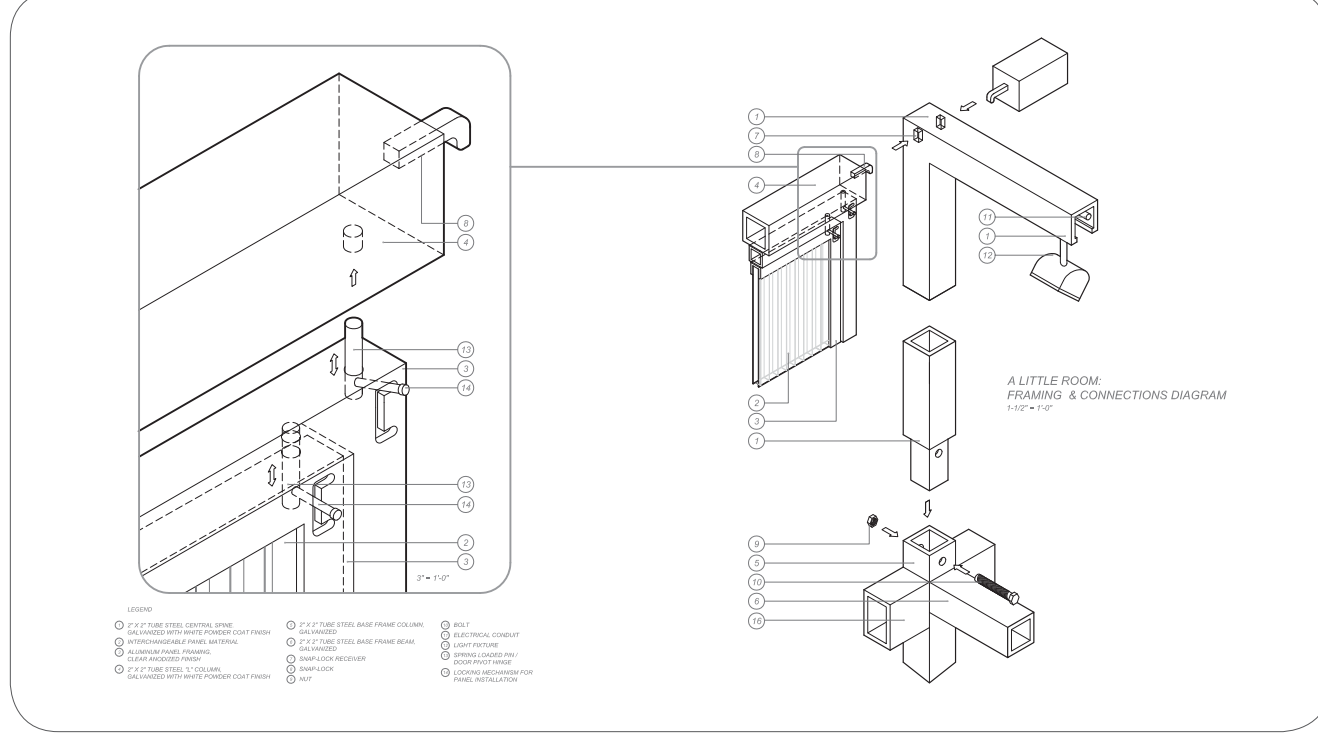
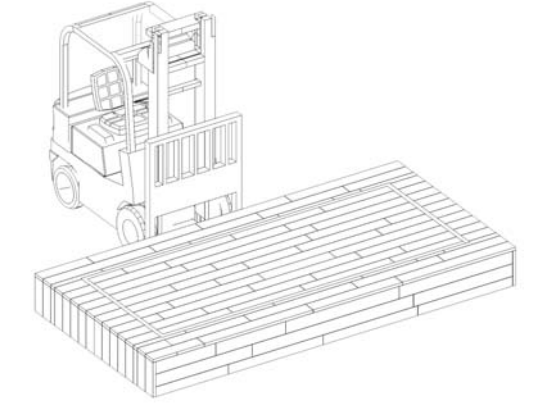

2

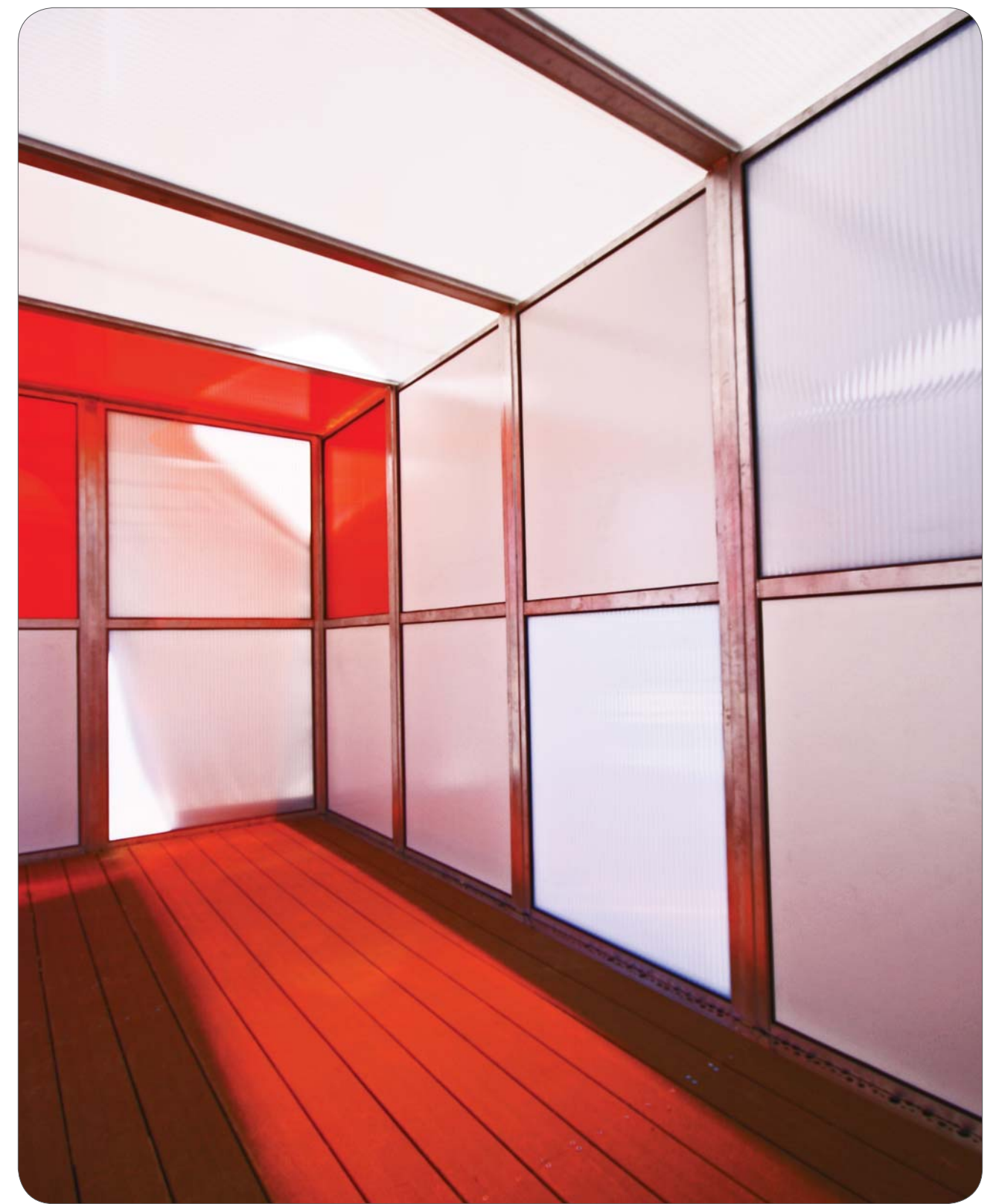
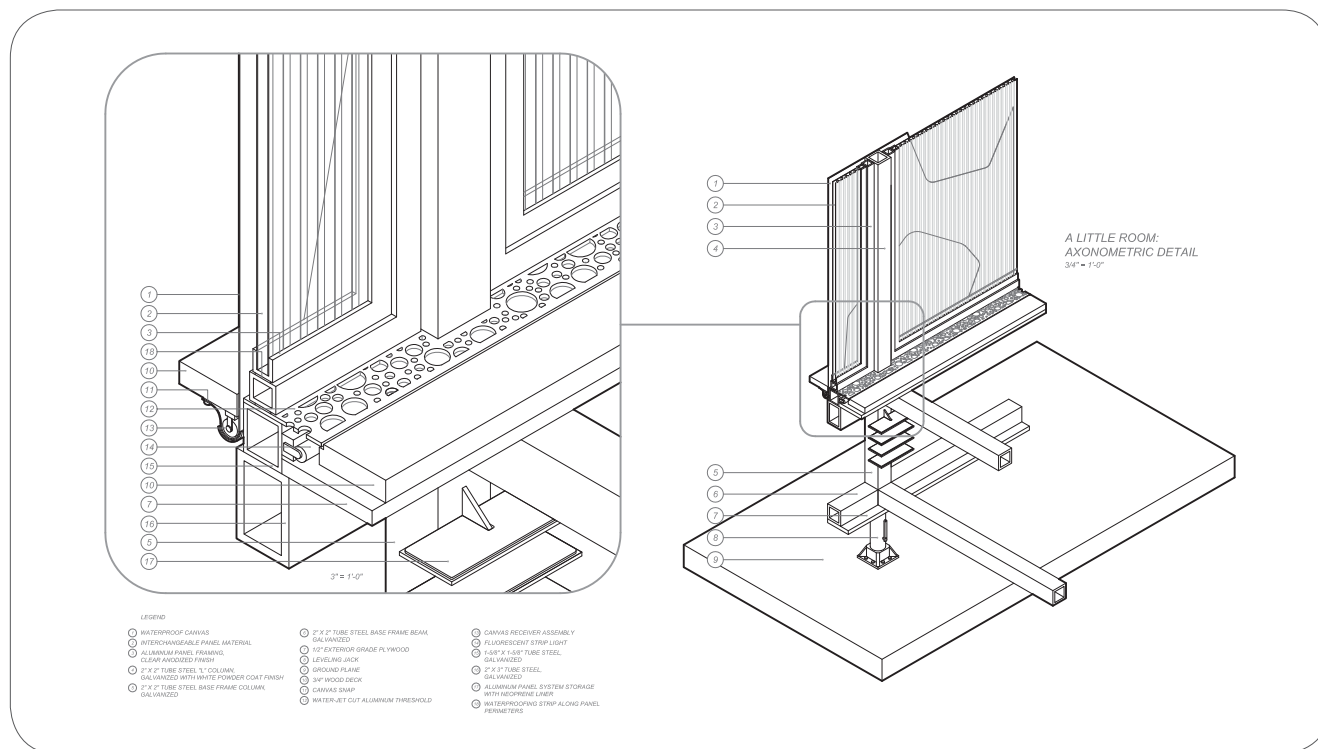
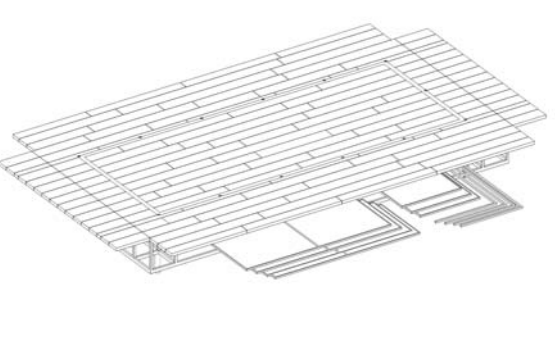

3

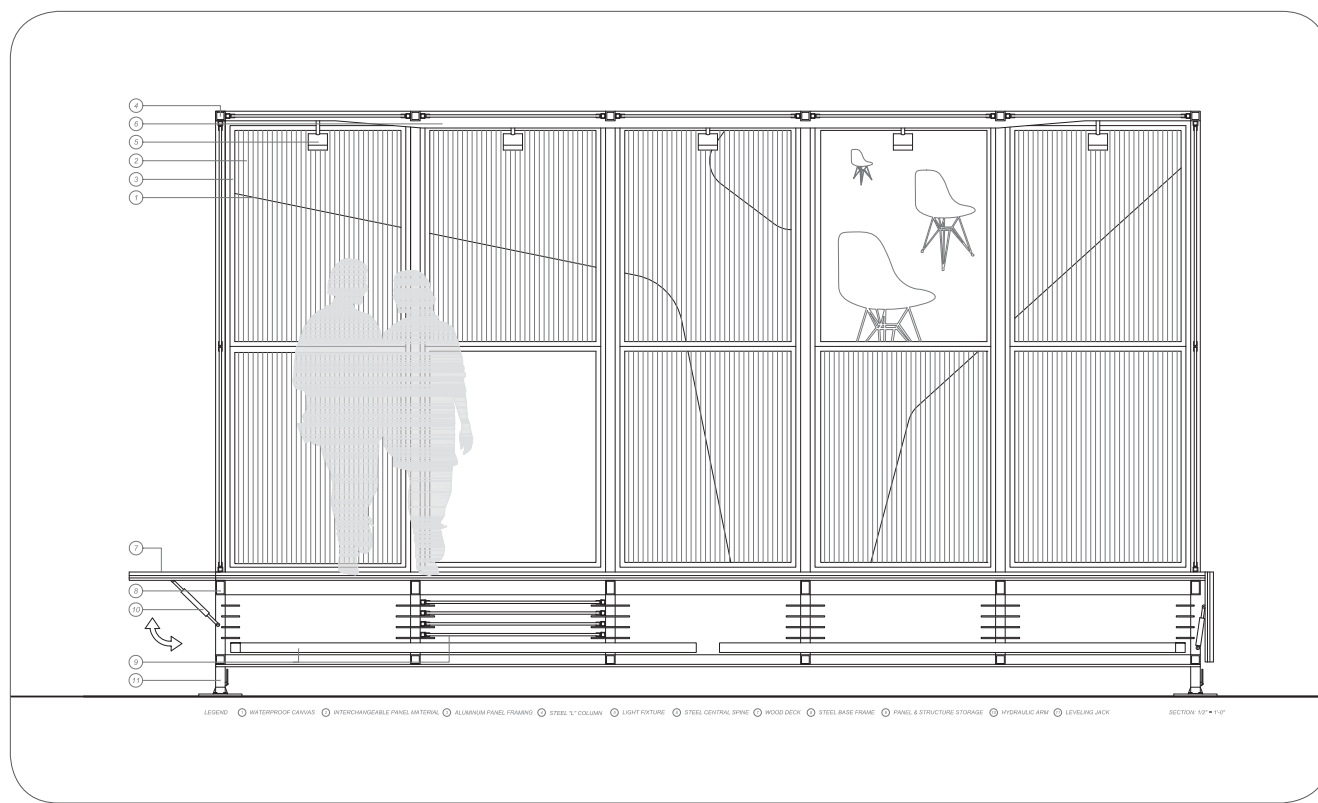
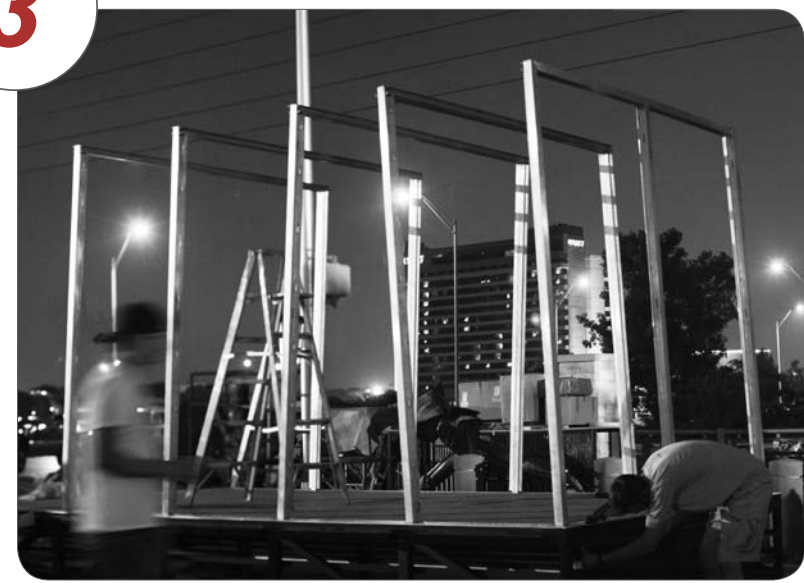
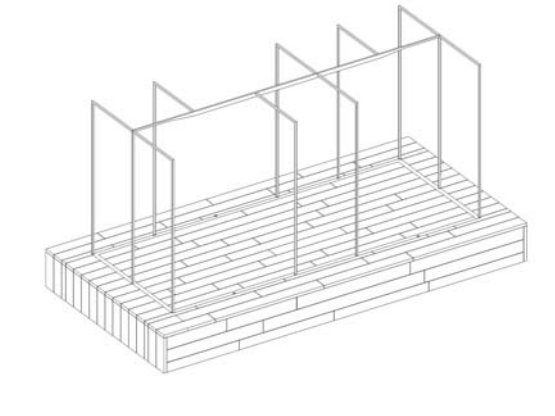

4

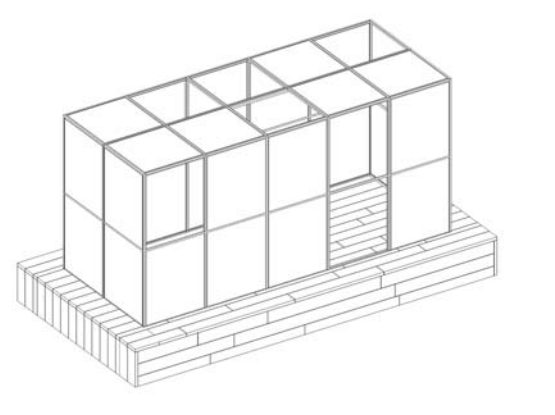

5

